







36 607 707



- rosette 60 x 60 mm
- with hot marking
- head part with cut-to-length spindle and sleeve

	Dark Chrome	36 607 707-19
	Chrome	36 607 707-00
	Brushed Platinum	36 607 707-06
	Brushed Champagne (22kt Gold)	36 607 707-46
	Champagne (22kt Gold)	36 607 707-47
	Brushed Dark Platinum	36 607 707-99

36 607 707

mm [inches]

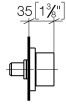

Certificates

LGA_29931.

WRAS_2010066.

36 607 707

Parts for other finishes can be found here: [Chrome](#)

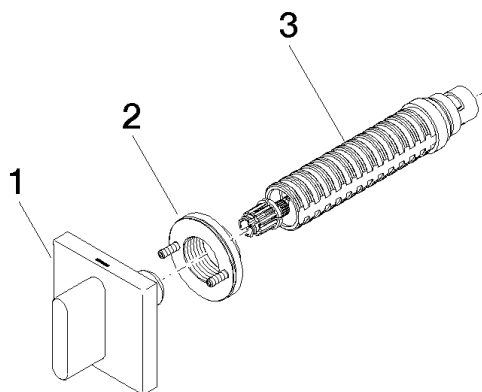

Spare parts list

No.	Item Number	Name	Quantity used	Delivery time
1	90 20 70 051 03-19	handle (hot)	1	20
2	90 21 02 108 00 90	disc	1	2
3	90 90 03 142 00 90	top	1	2